



DP0300LB&DP0300SB

半导体放电管

版本号
201603-A

产品概述

半导体放电管是一种过电压保护器件，是利用晶闸管原理制成的，依靠PN结的击穿电流触发器件导通放电，可以流过很大的浪涌电流或脉冲电流。

产品特点

- 双向过电压电路保护
- 抗浪涌能力强
- 快速反应，可恢复
- 漏电小，可靠性高
- 低电容

特征参数

应用领域

符号	额定值	单位
V_{DRM}	25	V
V_S	40	V
I_H	50	mA

DP0300半导体放电管主要应用于通讯设备的过电压防护；家用电器，工控仪器的过电压防护。

封装：SMB (DO-214AA)，DO-15

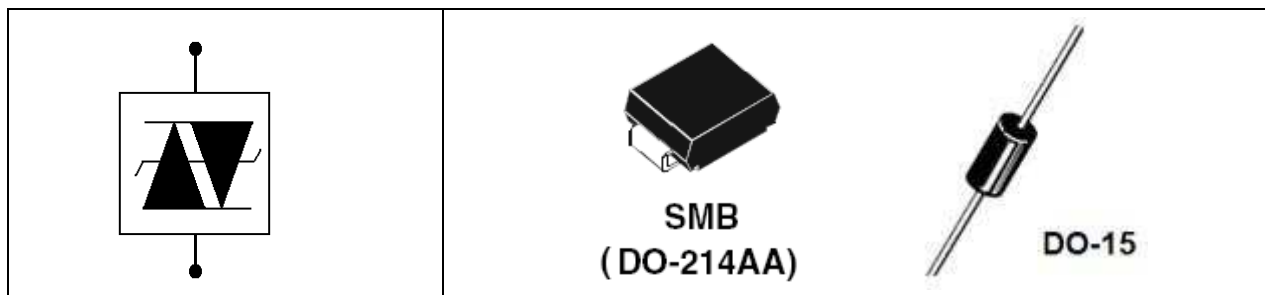

电参数

参数名称	符号	测试条件	规范值			单位
			最小	典型	最大	
不动作电压	V_{DRM}	$I=5\mu A$	25			V
不动作电流	I_{DRM}	$V=V_{DRM}$ 额定值			5	μA
跃变电压	V_S	100KV/s			40	V
跃变电流	I_S	100KV/s			800	mA
维持电流	I_H	10A, 10/1000 μs	150			mA
通态电压	V_T	$I_T=2.2A$			4	V
通态电流	I_T	额定值		2.2		A
极间电容	C_o	1MHz, 2V偏置			50	pF
峰值浪涌电流	I_{PP}	10/1000 μs	80			A
峰值浪涌电压	V_{PP}	10/700 μs	4000			V



■ 热特性

符号	参数	数值	单位
T_J	工作结温范围	-40~+150	°C
T_S	贮存温度范围	-65~+150	°C

■ 典型特性曲线

浪涌电流波形

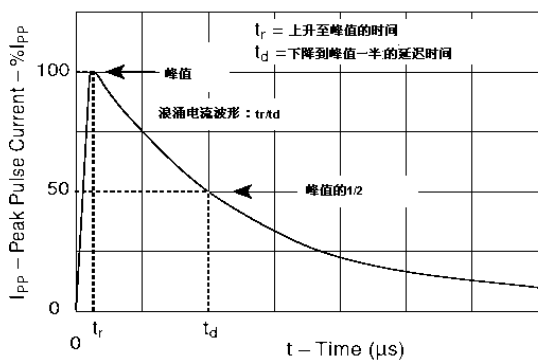
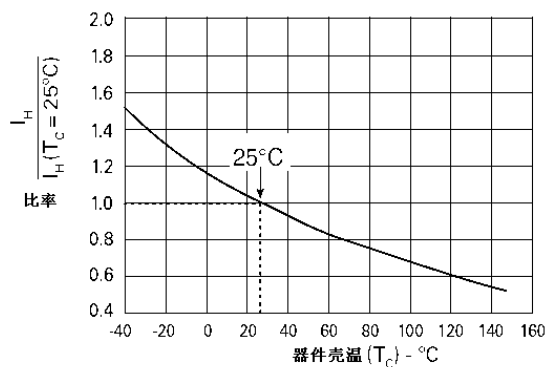
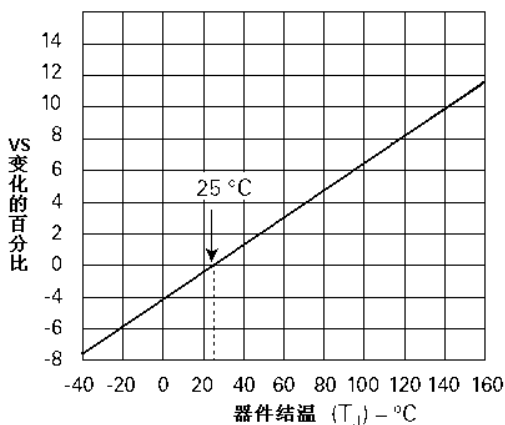
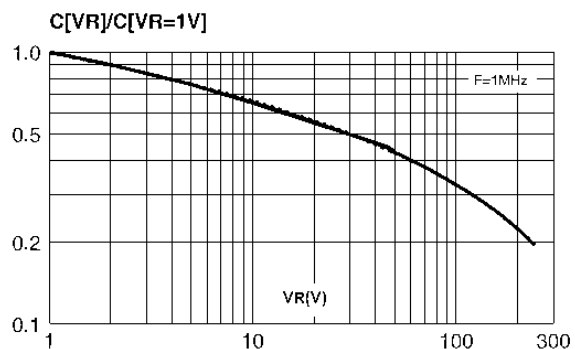
 I_H 随温度变化率 V_S 随结温变化率 C_o 随偏置电压的变化率（相对于 $V_R=1V$ ）



封装尺寸

SMB
(DO-214AA)

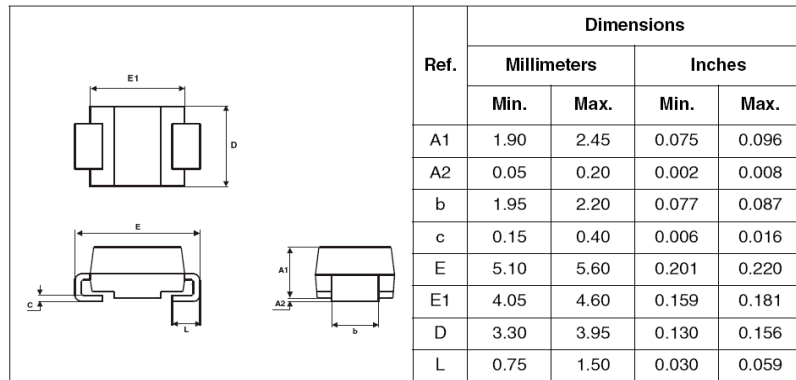

DO-15

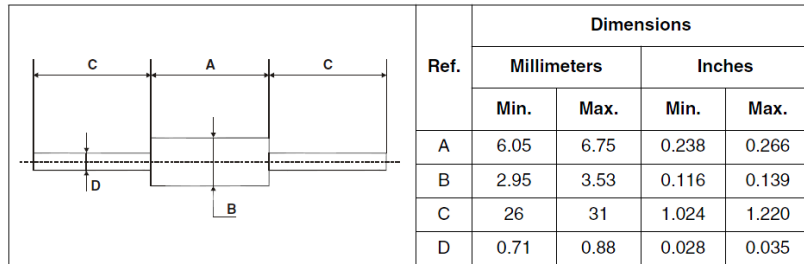

命名规则

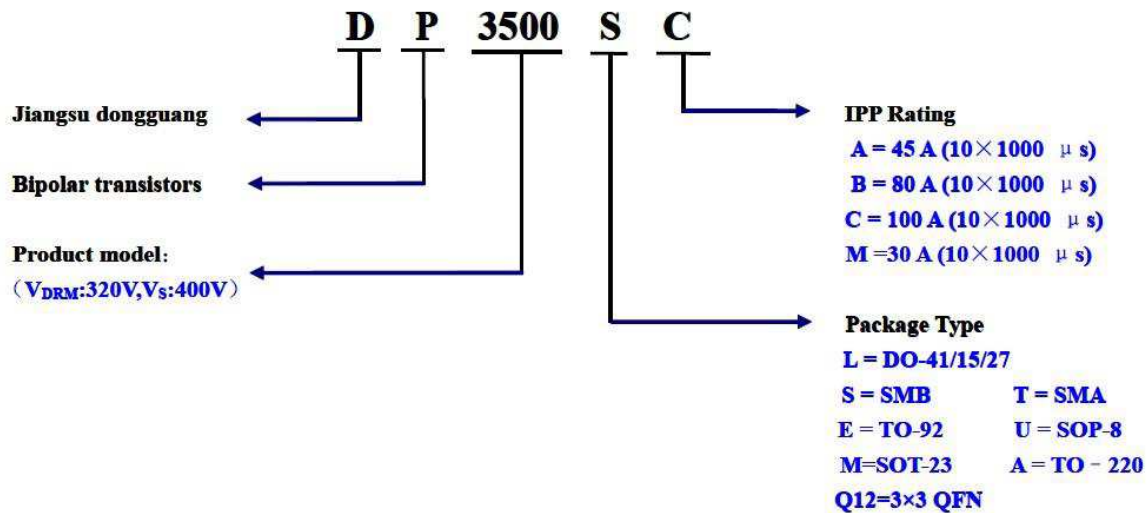



DP0300LB&DP0300SB



半导体放电管

版本号
201603-A

Description

The SDT is a kind of overvoltage protection device. It is designed at the PNP structure. High pulse current can cross SDT.

Features and Benefits

- Low voltage and overshoot
- Low on-state voltage
- Does not degrade with use
- Fails short circuit when surged in excess of ratings
- Low capacitance

Characteristic parameters

应用领域

symbol	Rated value	unit
V_{DRM}	25	V
V_S	40	V
I_H	50	mA

DP0300 are designed to protect communication equipment, appliances and Industrial And Control Instrumentation Equipment from damaging overvoltage transients.

Package : SMB (DO-214AA), DO-15

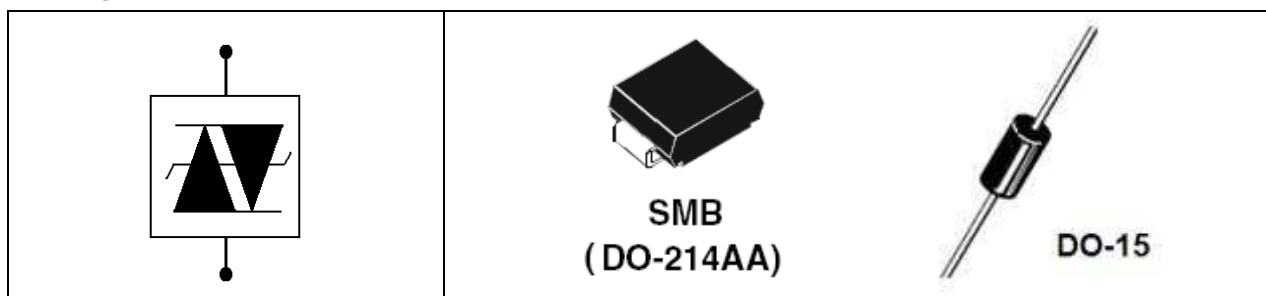

Electrical Parameters

Parameter	symbol	Test conditions	Value			unit
			Min.	Typ.	Max.	
Leakage Voltage	V_{DRM}	$I=5\mu A$	25			V
Leakage Current	I_{DRM}	$V=V_{DRM}$			5	μA
Switching Voltage	V_S	100KV/s			40	V
Switching Current	I_S	100KV/s			800	mA
Holding Current	I_H	10A, 10/1000 μs	150			mA
On-state Voltage	V_T	$I_T=2.2A$			4	V
On-state Current	I_T	Rating value		2.2		A
Off-state Capacitance	C_o	1MHz, 2V offset			50	pF
Peak Pulse Current	I_{PP}	10/1000 μs	80			A
Peak Pulse Voltage	V_{PP}	10/700 μs	4000			V



■ 热特性

Symbol	Parameter	Value	Unit
T_J	Operating Junction Temperature	-40~+150	°C
T_S	Storage Temperature Range	-65~+150	°C

■ Typical characteristic curve

Tr x Td Pulse waveform

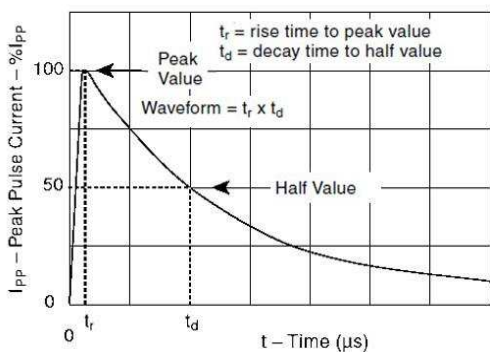

Normalized DC holding current vs. case temperature

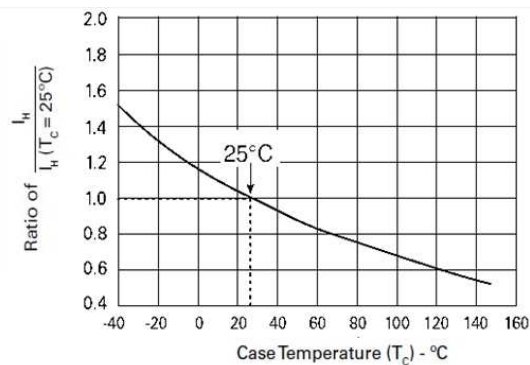

Vs change vs. junction temperature

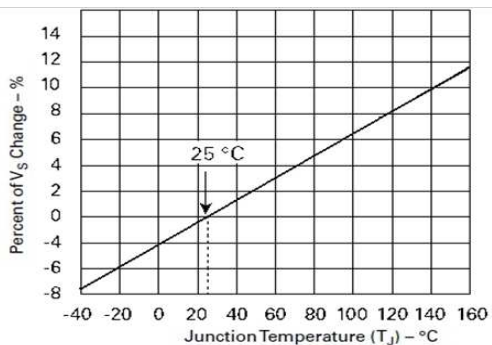

Co change vs. bias voltage (V_R=1V)

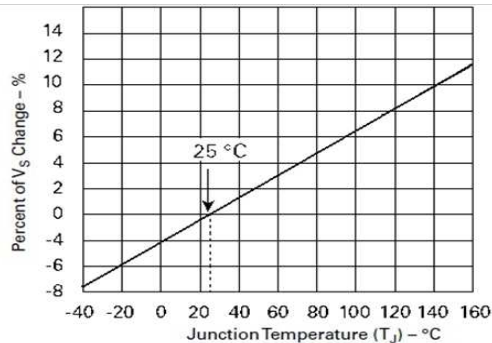



Package size

SMB
(DO-214AA)

Ref.	Dimensions			
	Millimeters		Inches	
	Min.	Max.	Min.	Max.
A1	1.90	2.45	0.075	0.096
A2	0.05	0.20	0.002	0.008
b	1.95	2.20	0.077	0.087
c	0.15	0.40	0.006	0.016
E	5.10	5.60	0.201	0.220
E1	4.05	4.60	0.159	0.181
D	3.30	3.95	0.130	0.156
L	0.75	1.50	0.030	0.059

DO-15

Ref.	Dimensions			
	Millimeters		Inches	
	Min.	Max.	Min.	Max.
A	6.05	6.75	0.238	0.266
B	2.95	3.53	0.116	0.139
C	26	31	1.024	1.220
D	0.71	0.88	0.028	0.035

Naming Rule

